

SECTION A-A

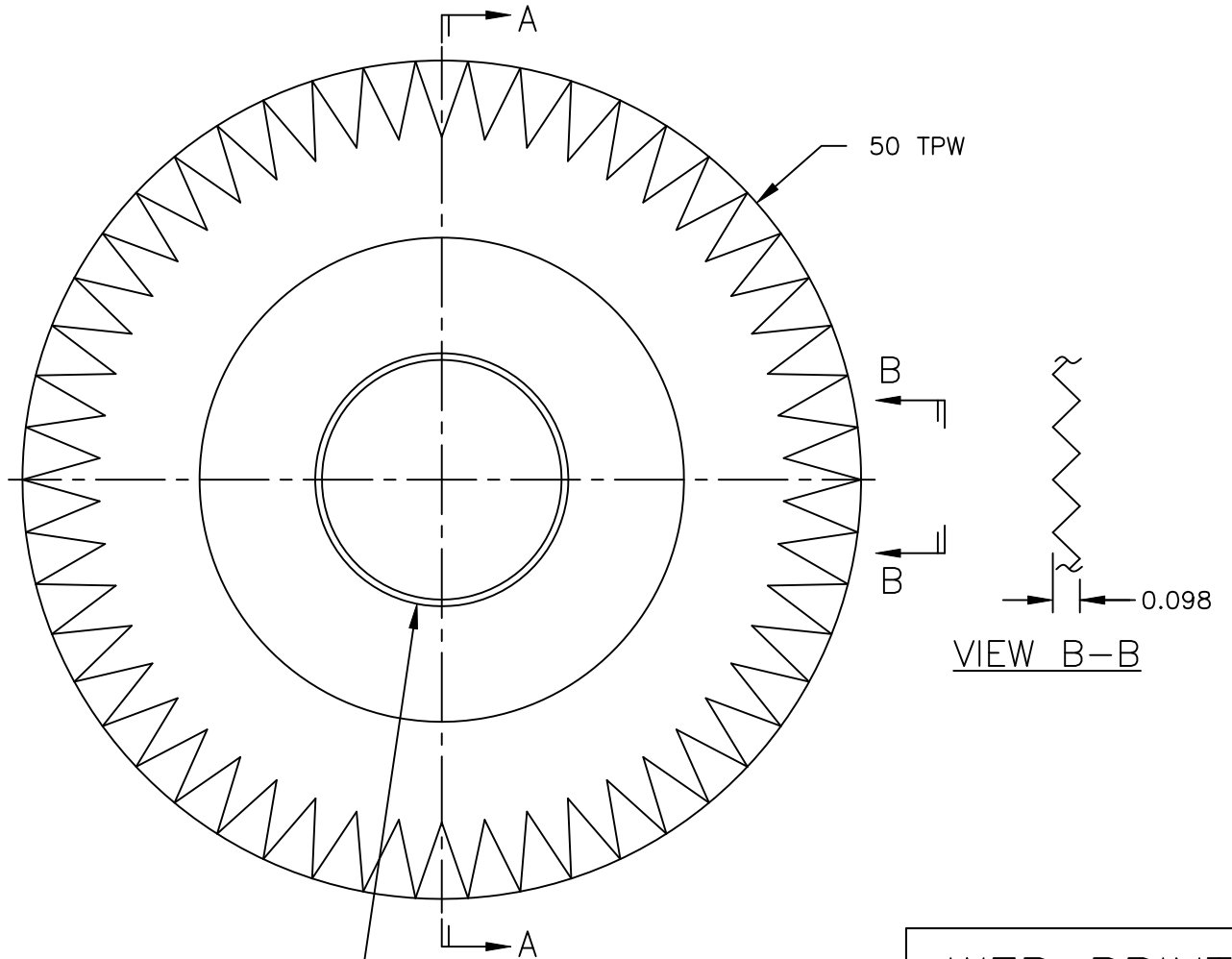

ID tolerance per customer requirements.

WEB PRINT

Pinker knives are typically made from 52100 or D2 steel and heat treated, to a hardness specified by customer requirements, up to 63 R/C.

PORTAGE KNIFE COMPANY

MANUFACTURER OF
SCORE SLITTERS
AND PERFORATORS

A DIVISION OF PORTAGE MACHINE CONCEPTS, INC. AKRON, OHIO (330) 784-0700

300P-50-098 Circular Knife

SIZE
A

DWG NAME:
W300P-50-098.dwg

SCALE: NONE

DATE: 10/30/2018

DRAWN: D. MILLER

SHEET: 1 OF 1