

SECTION A-A

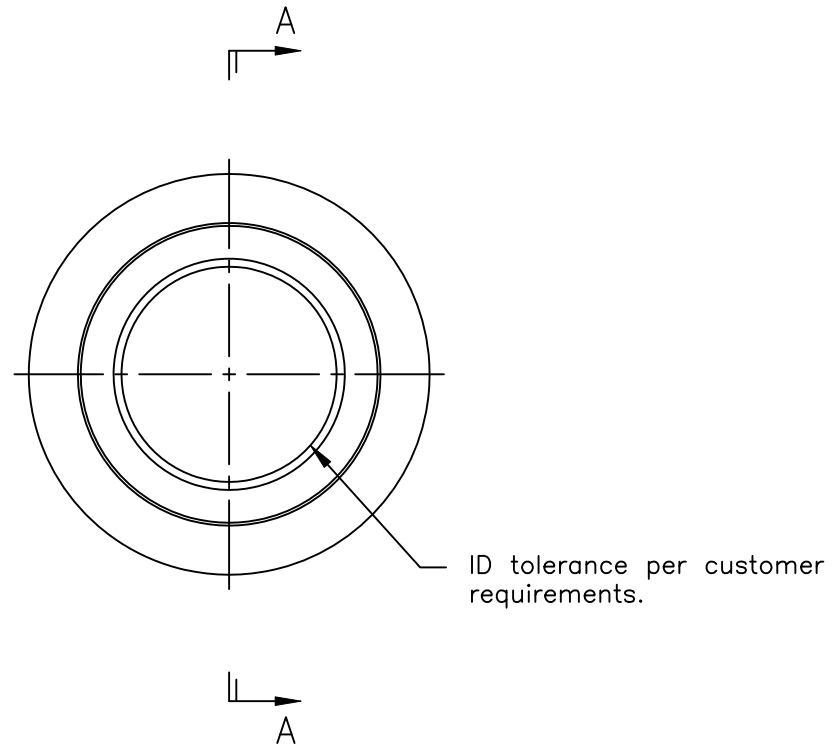

WEB PRINT

Circular knives are manufactured from D2, heat treated to a hardness of 57-59 R/C.

**PORTAGE KNIFE COMPANY** MANUFACTURER OF SCORE SLITTERS AND PERFORATORS  
A DIVISION OF PORTAGE MACHINE CONCEPTS, INC. AKRON, OHIO (330) 784-0700

137-40-0025-D2 Circular Knife

SIZE A	DWG NAME: W137-40-0025-D2.dwg
-----------	----------------------------------

SCALE: NONE	DATE: 2/9/2021	DRAWN: D. MILLER	SHEET: 1 OF 1
-------------	----------------	------------------	---------------