

SECTION A-A

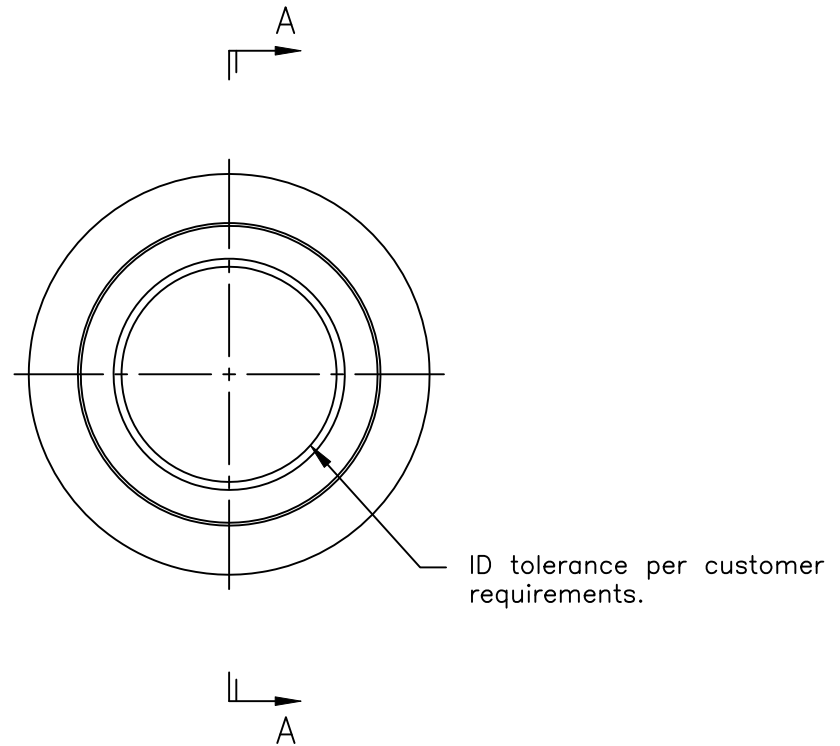

WEB PRINT

Circular knives are manufactured from D2, heat treated to a hardness of 57-59 R/C.

PORTAGE KNIFE
COMPANY

MANUFACTURER OF
SCORE SLITTERS
AND PERFORATORS

A DIVISION OF PORTAGE MACHINE CONCEPTS, INC. AKRON, OHIO (330) 784-0700

137-40 Circular Knife

SIZE
A

DWG NAME:
W137-40.dwg

SCALE: NONE

DATE: 1/9/2018

DRAWN: D. MILLER

SHEET: 1 OF 1