

SECTION A-A

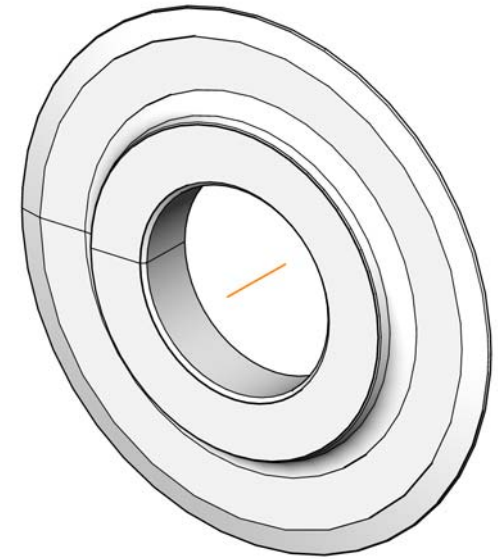
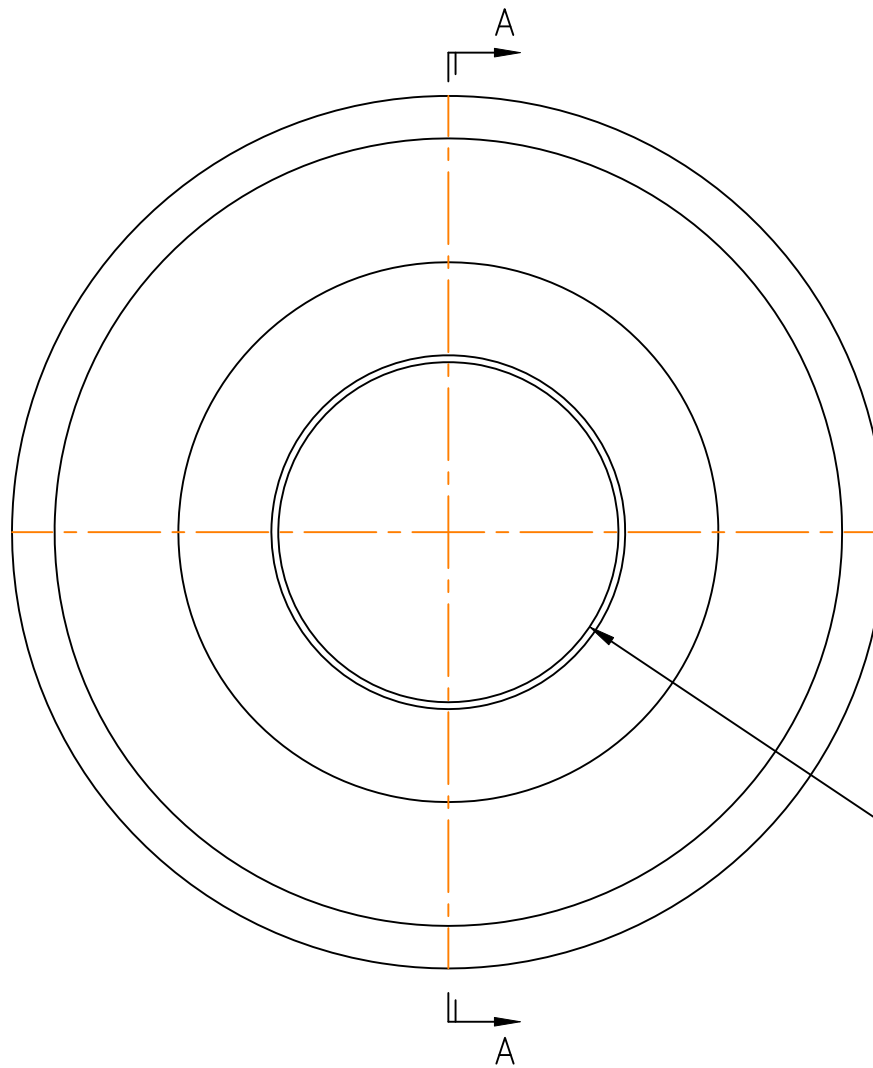

Standard Tolerance Bore

Website Drawing

Unless noted otherwise, all dimensions are nominal.

Circular knife is manufactured from 52100 material, heat treated to a hardness of 61-63 R/C.

PORTAGE KNIFE
COMPANY

MANUFACTURER OF
SCORE SLITTERS
AND PERFORATORS

A DIVISION OF PORTAGE MACHINE CONCEPTS, INC. AKRON, OHIO (330) 784-0700

360-30-007 Circular Knife

SIZE
A

DWG NAME:
W360-30-007.dwg

SCALE: NONE

DATE: 7/15/2021

DRAWN: D. MILLER

SHEET: 1 OF 1

This print and the intellectual content is the property of Portage Machine Concepts, Inc. and must not be copied, transmitted or disseminated, in any way, without the written permission of Portage Machine Concepts, Inc.